

CEDEC 2013 *Sponsorship Opportunities*

The Computer Entertainment Developers Conference (CEDEC) is an international technical conference organized by the Computer Entertainment Supplier's Association (CESA; an industry organization), with the aim of improving the technical abilities of the Computer Entertainment industry.

In an industry that is today experiencing dramatic innovation, the conference is positioned as one of the most important events along with the Tokyo Game Show. At the conference, you can share the latest technologies and business information across the borders, between the industrial, academic and governmental sectors.

CEDEC provides public relations programs and advertising opportunities in the form of exhibition spaces and sponsorship sessions. This is an ideal opportunity to promote your company's products and services directly to developers.

■ Outline

Dates	August 21(wed) – 23(fre), 2013
Venue	Pacifico Yokohama (Yokohama city, Kanagawa pref.)
Organizer	Computer Entertainment Supplier's Association (CESA)
Supporter	Ministry of Economy, Trade and Industry, Information Processing Society of Japan, Yokohama city, The Virtual Reality Society of Japan (planned)
Sessions	200 (planned)
Attendees	5,000 (expected)
Concurrent Event	CEDEC AWARDS, Welcome Reception, Developers Night, CEDEC CHALLENGE



1. Number of attendees

- Conference 3,455
- Speakers 302
- Job Seminar 155

Total 4,642

3. Attendees breakdown

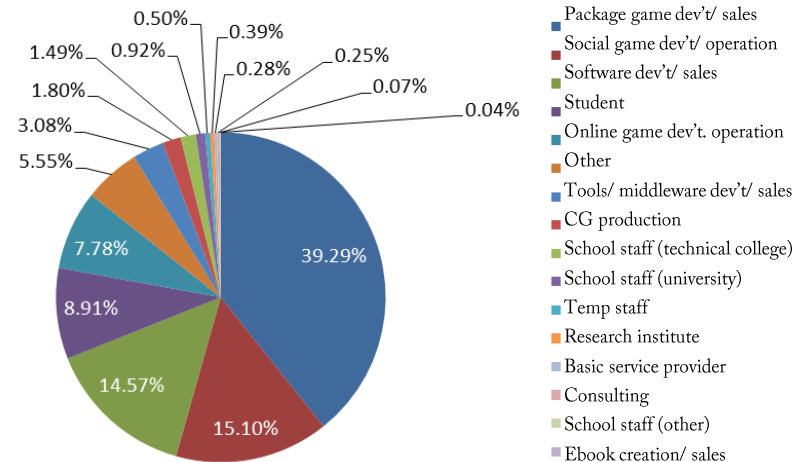

2. Media Coverage

1)Number of registered media on the day: 165
(Tv, Newspaper, Magazine, Web)

2)Number of Articles Published

Prior to the Event:123

After the event:243

(Including articles published during the event)

Total:366

Job category

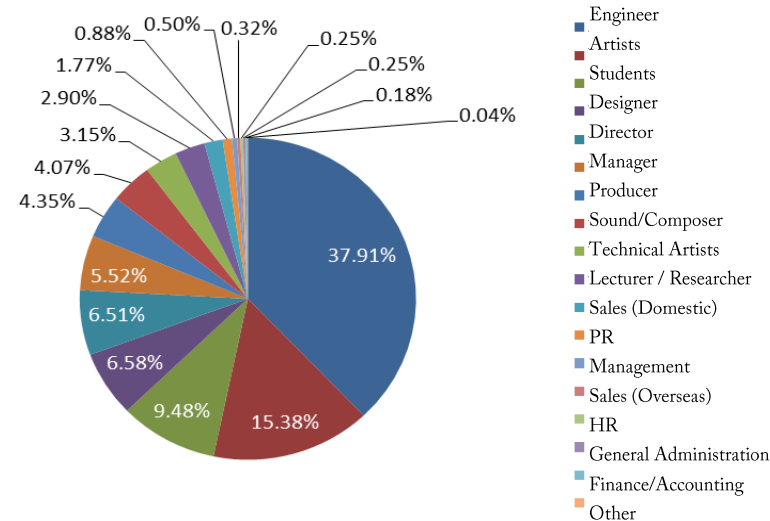

Main Sponsors

Platinum Sponsor



Gold Sponsor



Silver Sponsors



PR Program Sponsors

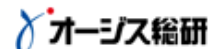

Media Partners



Event Cooperation / Equipment Sponsors



alphabetical order

Item			Price (5% tax is not included.)	Page			
Exhibition / Session	A	Exhibit Booth	Main-Exhibit Area (3rd floor)	Early Discount : 2600,00 JPY Regular Price : 320,000 JPY	5		
				*3 Tables Early Discount : 390,000JPY Regular Price : 480,000JPY			
			Sub-Exhibit Area (1st floor)	Early Discount : 180,000JPY Regular Price : 220,000JPY			
		B	Sponsorship Session (60min)	Room A (Capacity:144)		Early Discount : 370,000JPY Regular Price : 420,000JPY	8
				Room B (Capacity:285)		Early Discount : 740,000JPY Regular Price : 840,000JPY	
	Sponsorship Short Session (25min)		Room A (Capacity:144)	Early Discount : 240,000JPY Regular Price : 280,000JPY			
		Internet live broadcasting		3,000JPY	9		
	C	Sponsorship Workshop		100,000JPY	10		
	D	Book sales booth		20,000JPY (From 2nd booth, 15,000JPY) +Royalty (5% of sales)	11		
	Advertising	E	Lanyard Advertising*		1,640,000JPY	12	
F		Tote Bag Advertising*		1,260,000JPY	13		
G		Conference Pass Advertising*		340,000JPY	14		
H		Main Entrance Banner Advertising		320,000JPY	15		
I		Round Fan*		600,000JPY	16		
J		Drink Corner	1 day	460,000JPY	17		
			3 days	1,000,000JPY			
K		Mail Magazine Advertising	Five-line	42,000JPY	18		
			e-DM	110,000JPY			
L		Official Website Banner Advertising	A Type	210,000JPY	19		
			B Type	50,000JPY			
M		Program Guide Advertising	Back Side	Sponsor : 400,000JPY Non Sponsor : 450,000JPY	20		
			Cover 2	Sponsor : 320,000JPY Non Sponsor : 370,000JPY			
	Cover 3		Sponsor : 290,000JPY Non Sponsor : 340,000JPY				
	1 page		Sponsor : 160,000JPY Non Sponsor : 210,000JPY				
	Center 2 page		Sponsor : 400,000JPY Non Sponsor : 450,000JPY				

Item			Price (5% tax is not included.)	Page	
Advertisement	N	Screening Promotion Video between sessions	Main Hall*	1 day : 320,000JPY 3 days : 630,000JPY	21
			Room 503*	1 day : 250,000JPY 3 days : 500,000JPY	
			Room A	1 day : 210,000JPY 3 days : 420,000JPY	
	O	Outdoor Advertisement	Queen Mall Bridge	24 flag posts (48 faces) : 600,000JPY 12 flag posts (24 faces) : 400,000JPY	22
			Moving Walkway	48 flag posts (96 faces) : 1,000,000JPY 24 flag posts (48 faces) : 600,000JPY	
			Sakuragicho Station Plaza	24 flag posts (48 faces) : 800,000JPY 12 flag posts (24 faces) : 500,000JPY	
			Banner	460,000JPY	
			P	Interactive Session Monitor Advertising	
	Q	Tote Bag Insert		Sponsor : 10,000JPY Non sponsor : 30,000JPY	25
	Sponsorship	R	Developers' Night Sponsorship	Platinum*	1,500,000JPY
Gold				320,000JPY	
Exhibit Booth				110,000JPY	
S		Welcome Reception Sponsorship*	Platinum	1,500,000JPY	28
T		CEDEC AWARDS Sponsorship	Platinum*	1,000,000JPY	29
			Gold	320,000JPY	
U	Lounge Sponsorship		210,000JPY	30	
V	Press Room Sponsorship		210,000JPY		
Others	W	CEDiL Web Banner	A Type	300,000JPY	31
			B Type	150,000JPY	

Early Discount Deadline for Exhibit booth and Sponsorship session is May 31, 2013.

Items marked with "*" are available for one company only.

-If there are multiple parties applying for these items before May 17, a lottery will be held for selection of the participant (participants will be selected on a first-come basis from May 18 onwards).

- Exhibit booths area for sponsors will be established at open spaces in the CEDEC venue.
- There will be many visitors wondering around the open spaces with enhanced opportunities for exhibitors to be exposed to the audience.
- These booths will provide a great opportunity for demonstration and marketing of new products as well as communication with visitors.
- Participants can select an exhibit booth from two areas available: at the entrance lobby on the 1st floor and the foyer on the 3rd floor. (Note: Specifications of the booth may vary depending on the exhibition booth area)

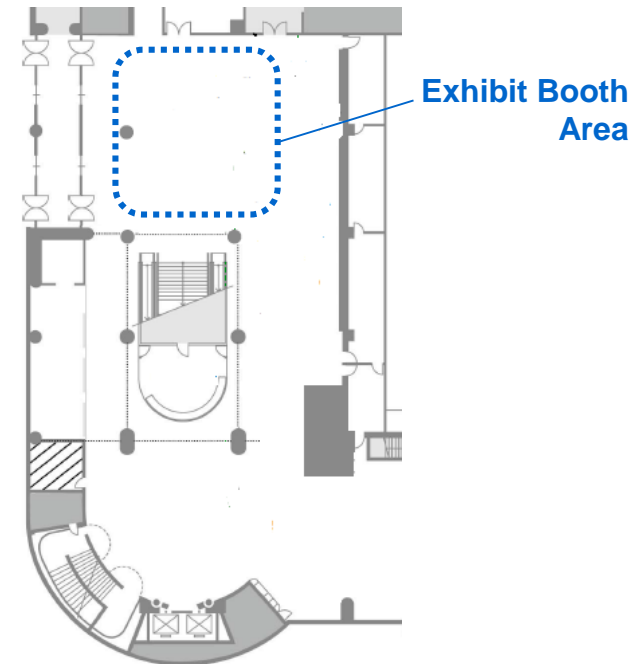
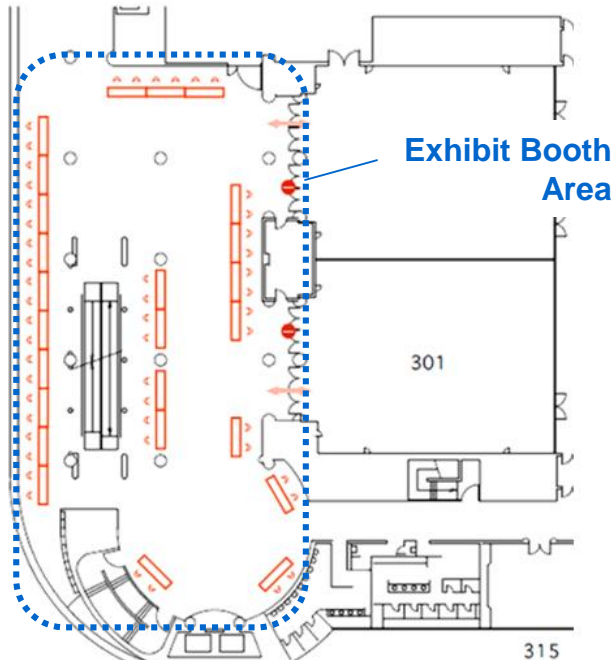

Photo from last year

■ Exhibit Booth Area

Main-Exhibit Area (3rd floor)

Sub-Exhibit Area (1st floor)



Main-Exhibit Area (3rd floor)

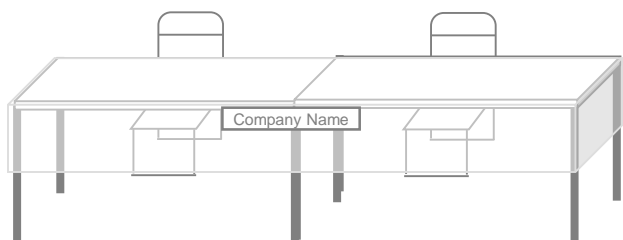

Image

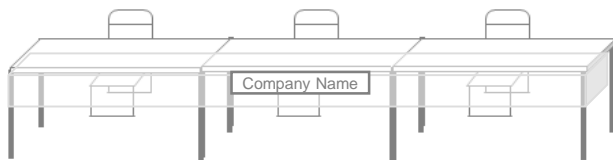

3 Tables Image

★SPEC

- Booth Space 3m x 2m
- 2 Tables(w1500, d600, h700) cloth covered
- 2 Chairs
- Signage (w600, h200)
- Electricity (1KW)
- 1 Full Conference Pass

★PRICE (5% tax is not included.)

Early Discount Price (By 5/31/2013):

260,000 JPY

Regular Price(After 6/1/2013):

320,000 JPY

Note: Up to three tables can be arranged in a booth (available only in the booths on the window side).

(Booth Space 4.5m x 2m, 3 Table, 3 Chairs)

Early Discount Price (By 5/31/2013):

390,000 JPY

Regular Price(After 6/1/2013):

480,000 JPY

Sub-Exhibit Area (1st floor)

NEW

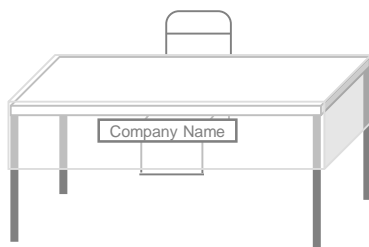

Image

★SPEC

- Booth Space 2m x 2m
- 1 Tables(w1500, d600, h700) cloth covered
- 1 Chairs
- Signage (w600, h200)
- Electricity (1KW)
- 1 Full Conference Pass

★PRICE (5% tax is not included.)

Early Discount Price (By 5/31/2013):

180,000 JPY

Regular Price(After 6/1/2013):

220,000 JPY

★Application

- Applications will be accepted on a first-come basis. The location of the booth is selected upon application.
- Presentation and sale of merchandising is not permitted at the exhibit booth areas.
- The booths layout may subject to change depending on the number of exhibitors.

★Options

Equipment listed below is also available. Please contact the secretariat for details.

*Internet Access (Wired)

*Bulletin Board

*Rack

*Additional Electricity

- Rooms adjacent to Exhibit space (3rd floor) will be booked for Sponsorship Session..
- You can introduce your products/services in this session
- Two rooms are prepared to accommodate different sizes of audiences.

Please specify the room your session requires.

Optional service: Live broadcasting of the session

★SPEC

- Session duration: 60 minutes / 25 minutes
- Projector, Microphone set, Internet Access (Wired)
- 1 Full Conference Pass

★PRICE (5% tax is not included.)

• Sponsorship Session (60min)

Room A (Capacity: 144)

Early Discount Price (By 5/31/2013)

370,000 JPY

Regular Price(After 6/1/2013)

420,000 JPY

Room B (Capacity: 285)

NEW

Early Discount Price (By 5/31/2013)

740,000 JPY

Regular Price(After 6/1/2013)

840,000 JPY

• Sponsorship Short Session (25min)

NEW

Room A (Capacity: 144)

Early Discount Price (By 5/31/2013)

240,000 JPY

Regular Price(After 6/1/2013)

280,000 JPY



Photo from last year

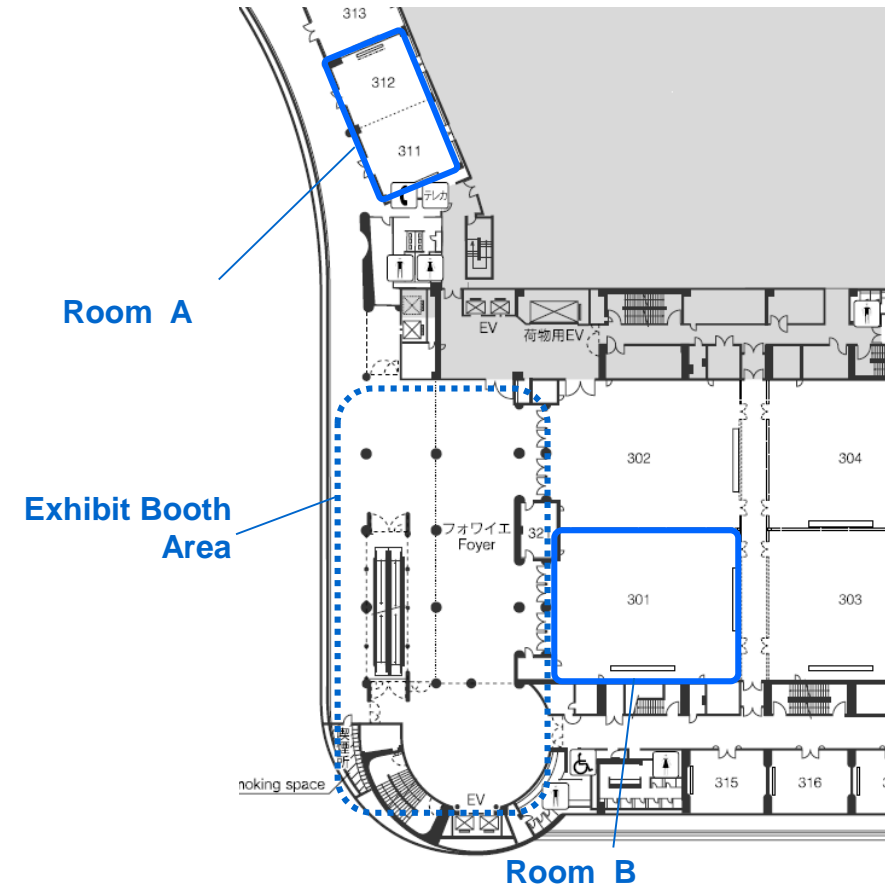

★Application

- Applications for the session will be accepted on a first-come basis (multiple applications are permitted).
- The venue may be subject to change. A different venue may be assigned depending on the timing of the application.

★Option

◇Live broadcasting of the session

NEW

- **Sessions are broadcasted live on the Ustream platform, an internet video distribution service.**

◆Specifications

Video quality: Equivalent to VGA

Camera: One fixed camera

Recording of the distributed video (within the Ustream server)

Report on the number of viewers

Price=**30,000 JPY** (5% tax is not included.)

Private arrangement of live broadcasting or video distribution of recorded sessions is not permitted.

- You can organize the workshop which the participants use your products with PC.
- At least two workshop sessions need to be included in the application.



Photo from last year

★ SPEC

- 60 minutes
 - Capacity 24
 - Electricity for PC
 - Internet Access (Wired)
- Price= **100,000 JPY** (5% tax is not included.)

★Application

- * One application must include at least two sessions.
- * This program is available for workshop sessions only.
To hold a lecture session, please apply for the sponsorship session.
- * Sessions applied for must be conducted on the same day.
- * Please bring your own PC for your presentation.
- * The price of projector is not included in the price. Please contact us if you need any projector or other equipment in your session.

- A book sale section “CEDEC Books” specialized in computer entertainment development will be set up at the CEDEC.
- CEDEC Books offers a great opportunity for direct communication with visitors and participants and offering unique services that are not otherwise available in a physical shop including discounts and sampling.
- Promotional events such as author’s autograph signing sessions are also available.



★SPEC

- Booth Space 2m x 2m
- Table(w1500, d600, h700) cloth covered and chair
- Signage (w600, h200)
- Location : Entrance Hall (1st floor)
- Sales setup: Books are sold at individual booths

Image

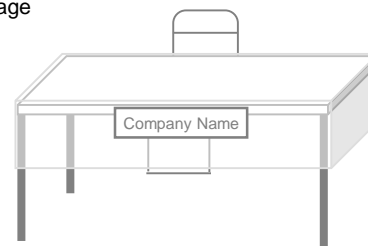

★PRICE

20,000 JPY (5% tax is not included.) + **royalty (5% of sales)**

- More than one booth can be set up. **15,000 JPY** (excluding 5% consumption tax) will be charged per booth from the 2nd booth.
- Sales report will be made after the CEDEC event for calculation of 5% royalty of sales.

★Application

- Applications are accepted on a first-come basis.
- In this program, only book sale is permitted (sale, exhibition or demonstration of non-book products are not permitted).

■ Entrance Hall (1st floor)

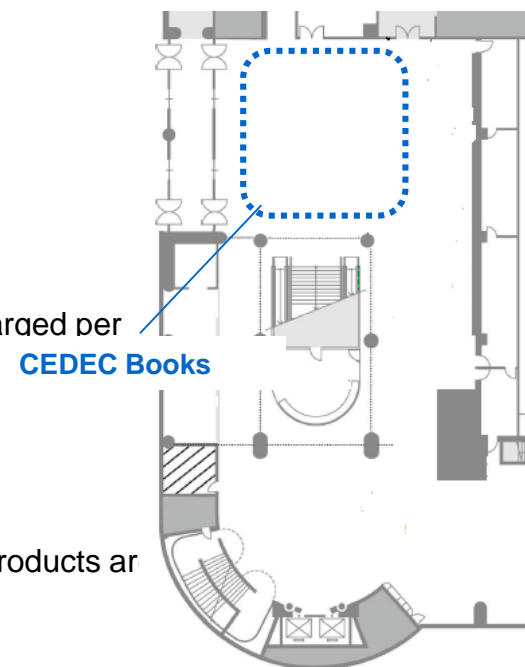

- Print your company's LOGO on the neck straps, which will be worn by all attendees, speakers
- This option is only available to sponsors who have applied for any of the exhibition/sponsorship menu

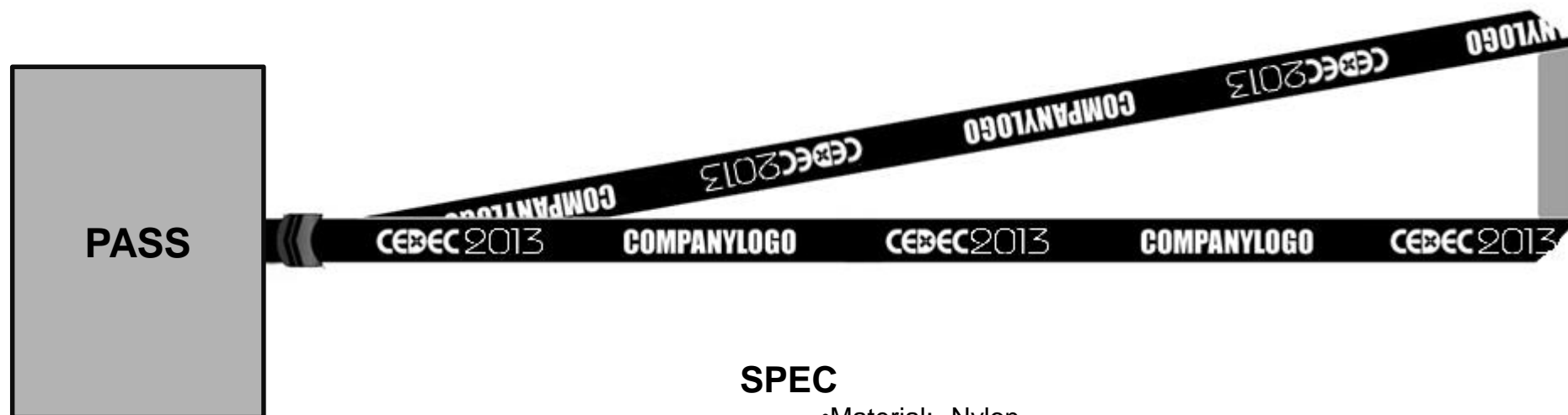

SPEC

- Material: Nylon
- Size: w15 h900 mm (planned)
- Color: 1C
- Distribution for: Attendees, Speakers, etc.

Price: **1,640,000 JPY** (5% tax is not included.)

Note: Only one lot is available.

If there are multiple parties applying for the lanyard advertising before May 17, a lottery will be held for selection of the advertiser (a advertiser will be selected on a first-come basis from May 18 onwards).

- Print your company's LOGO on the tote bags, which will be handed to all attendees, speakers
- This option is only available to sponsors who have applied for any of the exhibition/sponsorship menu

SPEC

- Material: non-woven
- Size: w280 h390 d50 (planned)
- Logo Size: up to w250 h340 (planned)
- Color: 1C
- Distribution for: Attendees, Speakers, etc.

Price: **1,260,000 JPY** (5% tax is not included.)

- ※Only one lot available.
- ※Layout on the left is just a sample
- ※shape/feature of the bag can be changed upon request.
Please contact the organizer for more details

Note: Only one lot is available.
If there are multiple parties applying for the lanyard advertising before May 17, a lottery will be held for selection of the advertiser (a advertiser will be selected on a first-come basis from May 18 onwards).



Image

- Print your company's LOGO on the conference pass, which will be worn by all attendees, speakers, and staff
- This option is only available to sponsors who have applied for any of the exhibition/sponsorship menu

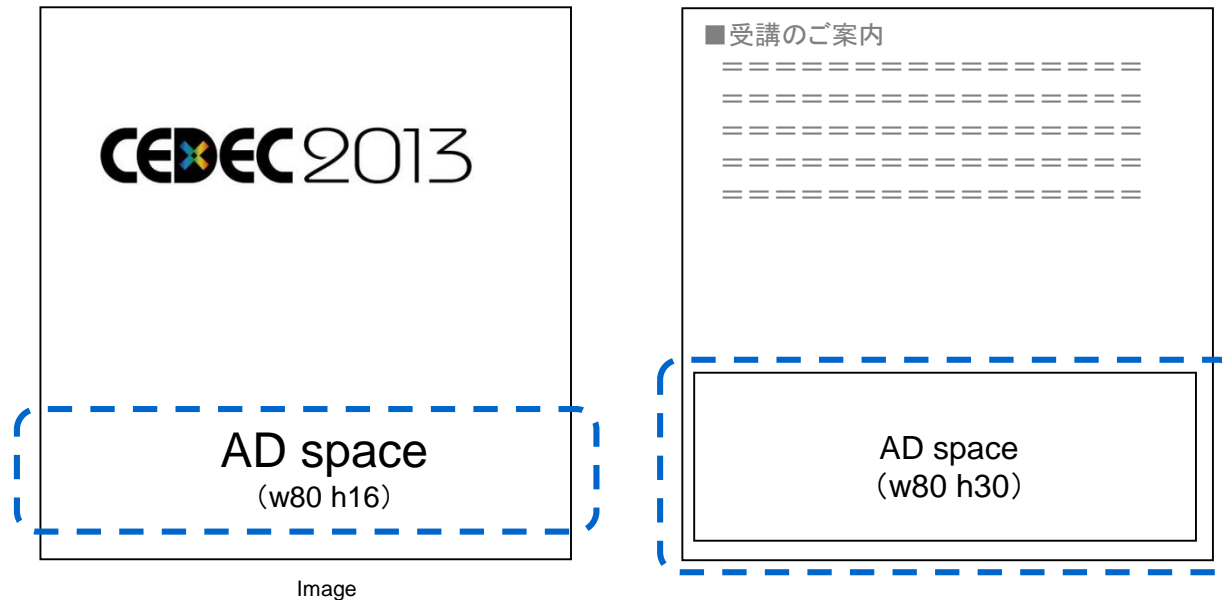

SPEC

- Material: Paper
- Size: w90 h90(planned)
- Color: 4C
- Distribution for: Attendees, Speakers, etc.

Price: **340,000 JPY** (5% tax is not included.)

Note: Only one lot is available.

If there are multiple parties applying for the lanyard advertising before May 17, a lottery will be held for selection of the advertiser (a advertiser will be selected on a first-come basis from May 18 onwards).

- Large banners near main entrance on the 2nd floor.
- The banners will be set up along the traffic line between the main entrance and the reception.
- This option is only available to sponsors who have applied for any of the exhibition/sponsorship menu.

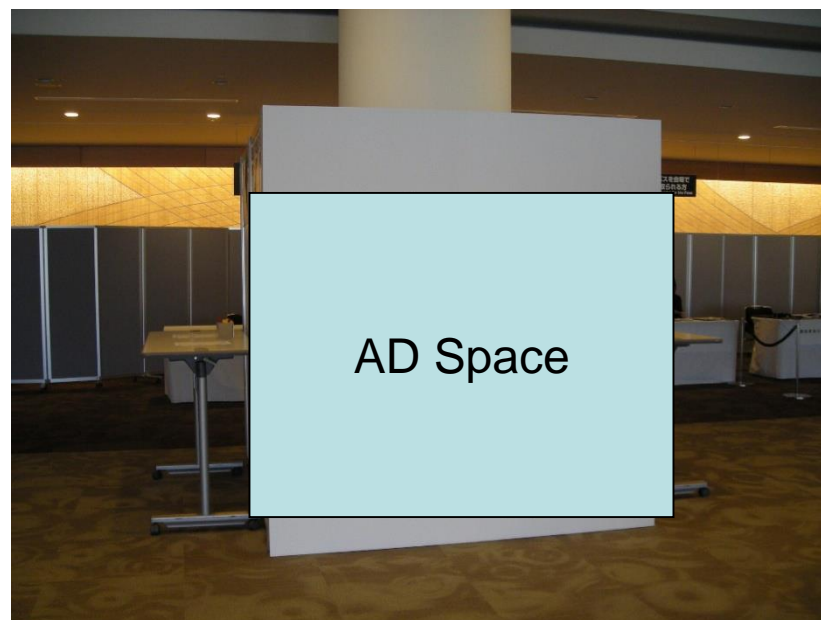

Image

SPEC

- Size: H 2400mm x W 1800mm
- Material: Self-supporting styrene board
- Venue: Main Entrance Area, 2nd floor. Near the reception
- # of boards: Max 4 locations

Price: **320,000 JPY** (5% tax is not included.)

※ One advertising surface. Multiple application accepted.

■ Main Entrance 2nd floor.

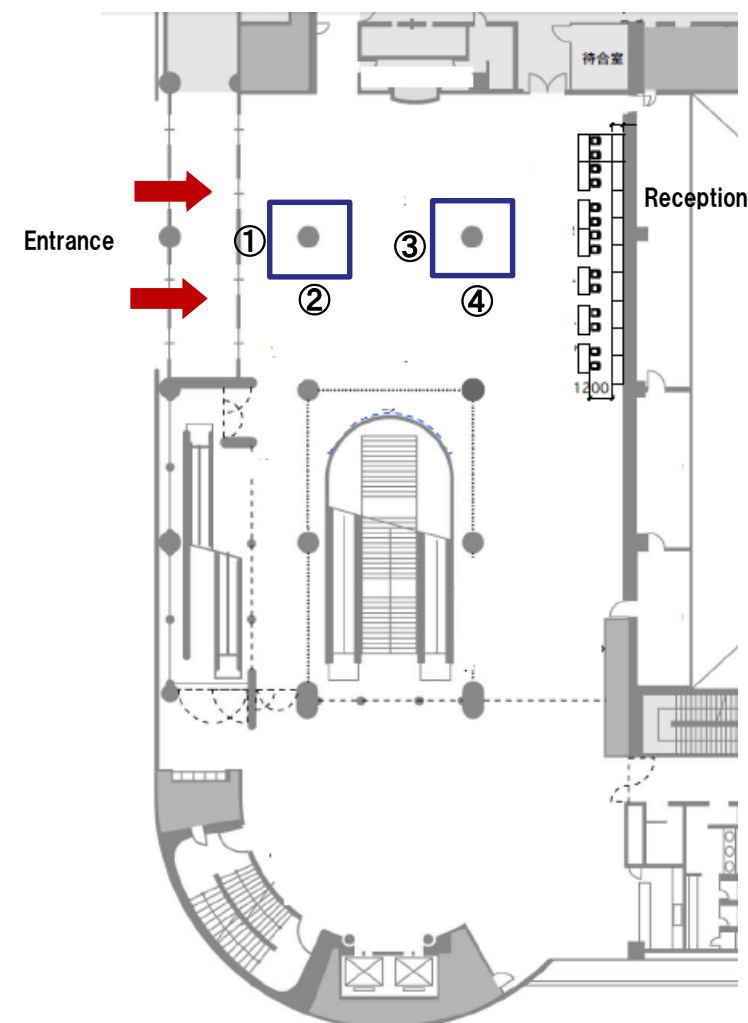

- Print your company's LOGO on the round fan, which will be handed to all attendees, speakers



Image

SPEC

- Size: w243 x h345 (planned)
- Flame: White
- AD Space:150mm x 110mm
- Color: 4C
- Distribution for: Attendees, Speakers, etc.

Price: **600,000 JPY** (5% tax is not included.)

※Layout on the left is just a sample

Note: Only one lot is available.

If there are multiple parties applying for the lanyard advertising before May 17, a lottery will be held for selection of the advertiser (a advertiser will be selected on a first-come basis from May 18 onwards).

- Display your company's LOGO in the free drink distribution area.
- This option is only available to sponsors who have applied for any of the exhibition/sponsorship menu



Photo from last year

SPEC

Location: 2 places in the Venue (planned)

Distribution for: Attendees, Speakers, etc.

- Bottled mineral water will be provided.
- Company logo can be printed on the bottle as an option (fees apply)

PRICE

1 Day / 460,000 JPY

3 Day / 1,000,000 JPY

(5% tax is not included.)

•Advertisement on official news letter “CEDEC EXPRESS”
Two options (Five-line AD in a news letter / advertising e-Direct Mail) available

CEDEC 2013 (コンピュータエンターテインメントデベロッパーズカンファレンス2013)
ニュースレター[CEDEC EXPRESS]

2013/**/**
<http://cedec.cesa.or.jp/>

■TOPICS

- ▼【お急ぎください】レギュラーパスの早期割引は本日まで！
- ▼【こちらも締切迫る！】あなたの一票がCEDEC AWARDSを決める！<本日まで>
- ▼【ハイライトセッション】アドバイザーボード推薦の3本！
- ▼【無料】スポンサーシップセッション受講登録受付中！
- ▼ 新着セッション公開中

---<PR>---

1 2 3 4 5 6 7 8 9 0 1 2 3 4 5 6 7 8 9 0 1 2 3 4 5 6 7 8
2
3
4
---<PR>---

▼【お急ぎください】レギュラーパスの早期割引は本日まで！

3日間にわたりすべてのセッションの受講が可能となる「レギュラーパス」のお申し込み
に適用される<早期割引>は、本日のお申し込み分までとなります。
ぜひ、この機会にお申し込みください！

●受講申込ページ
<http://cedec.cesa.or.jp/2013/contents/howto.html>

Example of “five-line” AD

SPEC

Send to: Attendees, speakers and registered subscribers to the news letter
of registered send-to addresses: Over 5,000 (as of Mar 2013)
Distribution period: Until Friday, August 30

① 5-line Ad

- Inserts to the newsletter “CEDEC EXPRESS”

•38 characters x 5 lines

Price: **42,000 JPY** (5% tax is not included.)

② e-DM

- Independent advertising emails

•38 characters x 150 lines

Price: **110,000 JPY** (5% tax is not included.)

Please note that depending on the circulation schedule of the CEDEC EXPRESS, your request for the preferred date of distribution may not be satisfied.

- Display your advertisement banner on every page of CEDEC Official Website
- This option is only available to sponsors who have applied for any of the exhibition/sponsorship menu



AD Space (A Type)
Location: Top
Displays on all pages

SPEC

- Running Period: after submission of the manuscript, to End of October 2013
- Displays at random (up to five lots)

A Type:
Top, w468 h60 pixel (planned)
Price: **210,000 JPY** (5% tax is not included.)

B Type:
On sidebar, w240 h60 pixel (planned)
Price: **50,000 JPY** (5% tax is not included.)

•GIF format (up to 20KB) or Flash format (up to 30 KB)

- ※five lots available (multiple application accepted)
- ※Size of the banners and the layout are subject to change.
- ※For submission method and schedule, please contact the management office.

CEDEC2012 Official WEB Access record

On-peak (July 1 to August 31)
Total Page View. 2,000,000
Ave. Sojourn Time: 4 min.
On-peak(Daily)
Page View 200,000/day
Ave. Sojourn Time: 3 min. 50 sec

Previous Official Website

AD Space (B Type)
Location: On sidebar
Displays on all pages

- Advertisement on the official guidebook, distributed to all attendees
- This option is available for non-sponsor companies as well as sponsor companies



SPEC

Size: A4 (297 x 210 mm) Full color

AD Space	Price (5% tax is not included.)		Size
	Sponsor	Non Sponsor	
Back Side	400,000 JPY	450,000 JPY	H 297 X W 210
Cover 2	320,000 JPY	370,000 JPY	
Cover 3	290,000 JPY	340,000 JPY	
1 Page, 4 Color	160,000 JPY	210,000 JPY	H297 x W420
Center 2 pages	400,000 JPY	450,000 JPY	

NEW



Previous Program Guide

- An exhibitor means a company that uses either an exhibitor or a sponsorship program.
- The Cover 2, 3 and 4 are available for one company only.
- If there are multiple parties applying for these programs before May 17, a lottery will be held for selection of the participant (participants will be selected on a first-come basis from May 18 onwards).

- Promotion Video will be screened between sessions
- Three room sizes available to choose
- This option is only available to sponsors who have applied for any of the exhibition/sponsorship menu



Main Hall (Capacity 1,000)



Room 503 (Capacity 400)



Room A (Capacity 300)

SPEC

- Venue:
- Main Hall (Capacity 1,000)
 - Room 503 (Capacity 400)
 - Room A (Capacity 300)

Timing: Before the commencement of the session

Duration of the video: Under 60sec

PRICE (5% tax is not included.)

- Main Hall : 1 Day / 320,000 JPY, 3 days / 630,000 JPY
- Room 503 : 1 Day / 250,000 JPY, 3 days / 500,000 JPY
- Room A : 1 Day / 210,000 JPY, 3 days / 420,000 JPY
- More than one venue can be applied for for Room A.

Application for the 2nd venue onward: 1 Day / 150,000 JPY, 3 days / 300,000 JPY (5% tax is not included.)

・Another eye-catching advertising opportunity is offered along the traffic line between the nearest stations (JR Sakuragi Sta. and Minato Mirai Sta. of Minato Mirai Line) and the CEDEC venue at the Pacifico Yokohama. Flags and banners with advertising spaces will be hoisted along these access paths with advertising spaces.

SPEC&PRICE (5% tax is not included.)

■ Advertising duration

During CEDEC event (3 days) August 21(Wed) – 23(Fri)

Flag

- A) Queen Mall Bridge W 500 × H 750mm
 - ・24 flag posts (all posts, 48 faces) 600,000 JPY
 - ・12 flag posts (half of the posts, 24 faces) 400,000 JPY
- B) Moving Walkway W 500 × H 750mm
 - ・48 flag posts (all posts, 96 faces) 1,000,000 JPY
 - ・24 flag posts (half of the posts, 48 faces) 600,000 JPY
- C) Sakuragicho Station Plaza W450 × H1,200mm
 - ・8 flag posts (32 faces) 800,000 JPY
 - ・4 flag posts (16 faces) 500,000 JPY

Banner

- D) Moving Walkway W9500 × H1000mm
 - ・One banner (one surface) 460,000 JPY

Note:

- Costs specified above include advertising, production, installation/ removal and application/ admin fees.
- All ad designs need to be examined (e.g. against the use of unapproved high intensity colors such as red and yellow) and approved by the Yokohama Minato Mirai 21 Corporation.
- If other companies participating in other events held in the Pacifico Yokohama at the same time as CEDEC request for ad spaces, our advertising offer may be limited to half of the flag posts available.



- Displays advertisements on all monitors, at Interactive Sessions space during free time
- Can be used to promote your company logo or play promotion movie
- This option is only available to sponsors who have applied for any of the exhibition/sponsorship menu



Photo from last year

SPEC

- Location: Entrance hall on 1st floor
- Number of monitors: 30 (planned)
- Displays at regular intervals, 10 sec per interval
- Displays a few dozen times a day for three days
- Played as a PowerPoint Slide show

Price: **52,000 JPY** (5% tax is not included.)

※Multiple application accepted.

Interactive Sessions space (planned))

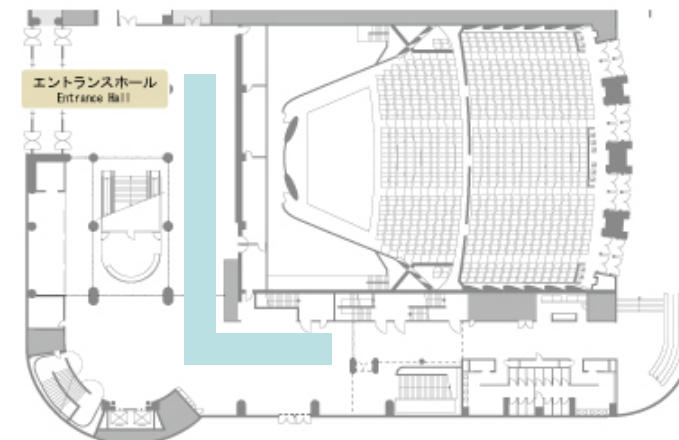

- Your brochure/catalog will be inserted into the Tote bags which will be handed to attendees

SPEC

- Size: within A4 sized brochure
- Distribution for: Attendees, Speakers, etc.

Price: Sponsor: **10,000 JPY** ※ For the sponsor who have applied for Exhibit booth or Sponsorship Session
Non Sponsor: **30,000 JPY**

(5% tax is not included.)

※This option may be cancelled if “E: Tote bag advertising” was not sponsored.

※Weight check will be performed for catalog

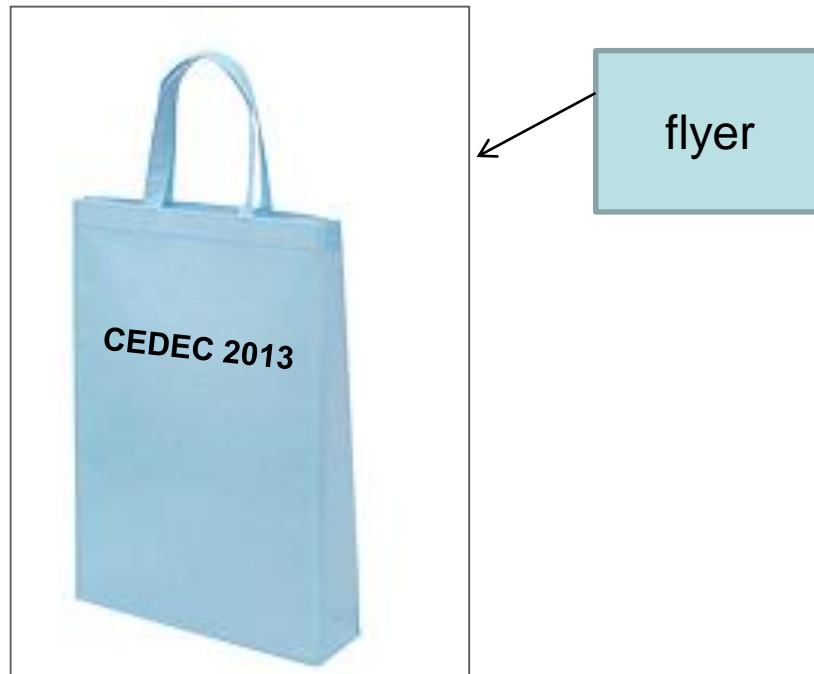

- “Developers' Night” is a party held after “CEDEC AWARDS”.
- Approximately 500 people (Speakers, attendees and guests) will be participating and networking.



Photo from last year

		Platinum	Gold
Price (5% tax is not included.)		1,500,000 JPY	320,000 JPY
Number of slots		1	3
Presentation on the stage		✓	—
Logo Awareness	Program Guide	✓	✓
	Official Website	✓	✓
	Signage at the venue	✓	✓
Demo Movie on the screen		✓	—
Brochure at the venue		✓	✓
Invitation Tickets		15	5

Overview
 Date: August 22 (Thu) 2013
 19:30 - 21:30
 Capacity:500

- Platinum sponsorship is limited to one company.
 ※Please prepare brochure / demo movie.

Option Menu ※This menu can be applied alone

*Exhibit Booth

Exhibit Booth in Party venue, for presenting products/demo.



Photo from last year

SPEC

- Tables (w1500 d600 h700) x 2, cloth-covered
- Company signature (w600 h200, in Gothic font)
- Power tap (1KW) m, power charge included

Price: **110,000 JPY** (5% tax is not included.)

※Multiple application accepted.

•On the first day of CEDEC, we will hold a welcome reception for the speakers/persons concerned in the sessions.

【Event Overview】

Date: August 21 (Wed) 2013

19:00~21:00

Capacity:200



Photo from last year

		Platinum
Price (5% tax is not included.)		1,500,000 JPY
Available Lot		One Company Only
Naming Right		✓
Demo Movie on the screen		✓
Opening Speech		✓
LOGO Exposure	Guidebook	✓
	Official Web site	✓
	Event Signboard	✓

※Please prepare brochure / demo movie.

- “CEDEC AWARDS” commends developers who have contributed to advance technologies in computer entertainment development by achieving .
- Organizer will proactively invite media coverage to increase media exposure of the sponsors.



【Overview】

Date/Time: August 22 (Thu) 2013 17:50~19:30
 Venue: 1st Floor, Main Hall
 Capacity: 1000 persons
 Categories: Engineering, Visual Arts, Game Design, Audio, Online/Network, Author Awards, Special Award

Photo from last year

		Platinum	Gold
Price (5% tax is not included.)		1,000,000 JPY	320,000 JPY
Number of lot		1	3
LOGO Exposure	Promotion Video Screening	✓ (60 sec)	✓ (30 sec)
	Guidebook	✓	✓
	Official Web site	✓	✓
	Event Signboard	✓	✓
	Photo Session LOGO Board	✓	—
Banner in event venue		✓	—

※ Please prepare brochure / demo movie.

- Supporting menu to provide soft drinks to attendees during coffee break time
- Conducted only when two companies (or two lots) applied

SPEC

- Logo Signage at the Lounge
- Brochure at the venue

Price: **210,000 JPY** (5% tax is not included.)

- *Drink will be served during the coffee break
- *Service will be finished as soon as the designated number of drinks has run out.
- *Brochure must be prepared by the sponsor.

■ Sponsorship V: Press Room Sponsorship

【 Deadline :July 12】

- Supporting menu to setup/operate Press Room for media
- Conducted only when two companies (or two lots) applied

SPEC

- Logo Signage at the Press Room
- Brochure at the venue
- 1 Press Release

Price: **210,000 JPY** (5% tax is not included.)

- *Brochure must be prepared by the sponsor.
- *For details, please ask the management office

- Display your advertisement banner on every page on CEDEC Digital Library(CEDiL).

CEDiL is the digital library of all presentation document delivered in CEDEC.
Not only during the CEDEC period, access to the website can be expected throughout the year.

SPEC

- Running Period: April 1st 2013 to End of March 2014
- Displays at random (up to five lots)

A Type: Top
Price: **300,000 JPY** (5% tax is not included.)

B Type: On sidebar,
Price: **150,000 JPY** (5% tax is not included.)

- GIF format (up to 20KB) or Flash format (up to 30 KB)

- ※five lots available (multiple application accepted)
- ※Size of the banners and the layout are subject to change.
- ※For submission method and schedule, please contact the management office.

CEDiL Website Access record

Total page view appx. 168,321(2012/121~2012/12/31)
Average page view per month 14,398
Post-event (2012/8,9 : 35,000PV, 2012/10 : 33,000PV)



Website image

AD Space (A Type)
Location: Top
Displays on all pages

AD Space (B Type)
On sidebar
Displays on all pages

- Can be used for business meeting

- This option is only available to sponsors who have applied for any of the exhibition/sponsorship menu

Image



SPEC

- Meeting Room

 - >79m², up to 32 persons

 - ※Room size may vary depending on availability

 - ※Microphones, Projectors, Screens are optional and need to be booked separately.

 - *For details, please ask the management office.

Please fill the Application form at the end of this presentation and send it by FAX or mail to our office
 (For Contact information, please refer to the section below)

- We will issue an invoice once application form is successfully received.
- Each advertisement item will be closed when it reaches the maximum capacity
- Cancellation charge may apply if cancellation date is closer to the event.

Cancellation Charge	Two months Prior to the event	30% of the fee
	One month Prior to the event	50% of the fee
	Less than one month	100% of the fee

【 Contact Information】

CEDEC Management Office
 c/o Nikkei Business Publications, Inc.
 1-17-3, Shirokane, Minato-ku, Tokyo 108-8646 Japan
 Tel: +813-6811-8082
 Fax: +813-5421-9172
 E-mail : sponsor@cedec.jp

Please fill out the form and send it by FAX or mail to our office.

Item			# Of Application OR Type/Number	
Exhibition / Session	A	Exhibit Booth	Main-Exhibit Area (3rd floor)	booth(s)
			Sub-Exhibit Area (1st floor)	booth(s)
	B	Sponsorship Session (60min)	Room A (Capacity:144)	session(s)
			Room B (Capacity:285)	session(s)
			Room A (Capacity:144)	session(s)
		Sponsorship Short Session(25min)		session(s)
	Internet live broadcasting			
C	Sponsorship Workshop		session(s)	
D	Book sales booth		booth(s)	
Advertising	E	Lanyard Advertising*		
	F	Tote Bag Advertising*		
	G	Conference Pass Advertising*		
	H	Main Entrance Banner Advertising		
	I	Round Fan*		
	J	Drink Corner		1 day · 3days
	K	Mail Magazine Advertising	Five-line	
			e-DM	
	L	Official Website Banner Advertising	A Type	
			B Type	
	M	Program Guide Advertising	Back Side	
Cover 2				
Cover 3				
1 page				
Center 2 page				
Advertisement	N	Screening Promotion Video between sessions	Main Hall* 1 day · 3days	
			Room 503* 1 day · 3days	
			Room A 1 day · 3days	
	O	Outdoor Advertisement	Queen Mall Bridge	
			Moving Walkway	
			Sakuragicho Station Plaza	
	Banner			
P	Interactive Session Monitor Advertising			
Q	Tote Bag Insert			
Sponsorship	R	Developers' Night Sponsorship	Platinum*	
			Gold	
			Exhibit Booth	
	S	Welcome Reception Sponsorship*		Platinum
	T	CEDEC AWARDS Sponsorship		Platinum* Gold
U	Lounge Sponsorship			
V	Press Room Sponsorship			
Others	W	CEDIL Web Banner	A Type	
			B Type	

Company Name		
Address	Postal Code	
Person in charge of application	Title	
	Name	
Principal Contact	Title	
	Name	
	TEL	
	FAX	
	E-mail	

Early Discount Deadline for Exhibit booth and Sponsorship session is May 31, 2013.

Items marked with "*" are available for one company only.

-If there are multiple parties applying for these items before May 17, a lottery will be held for selection of the participant (participants will be selected on a first-come basis from May 18 onwards).

[Cancellation Charge]

2 months Prior to Event: 30%, 1 month Prior to Event: 50% , Less than 1 month: 100%

[Please send your Application Form to]

CEDEC Management Office

c/o Nikkei Business Publications, Inc.

1-17-3, Shirokane, Minato-ku, Tokyo 108-8646 Japan

Tel:+813-6811-8082

Fax:+813-5421-9172

E-mail : sponsor@cedec.jp